

4

3

2

1

REVISIONS

REV	DESCRIPTION	DATE	APPROVED
-----	-------------	------	----------

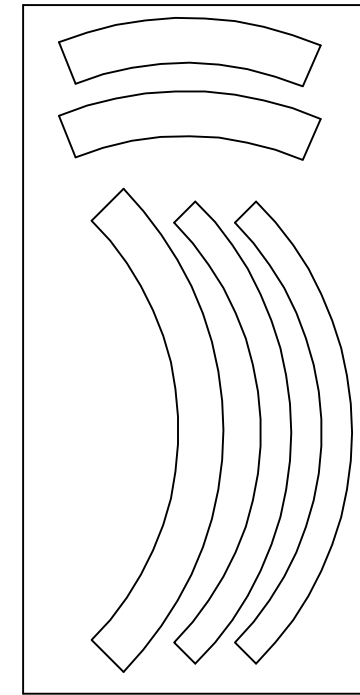
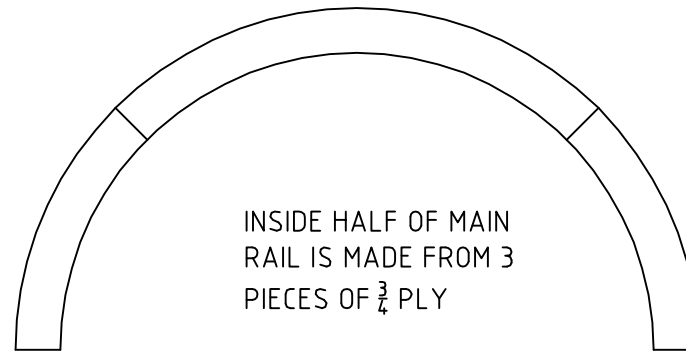
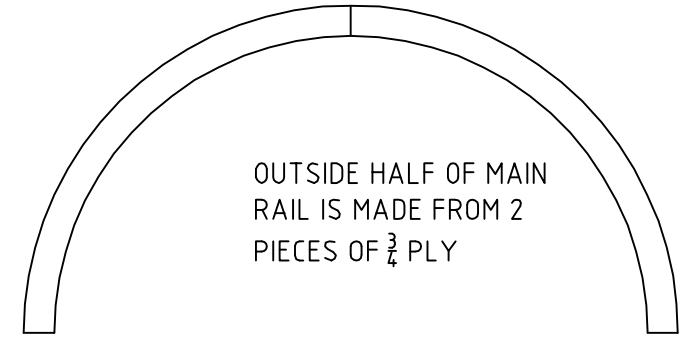
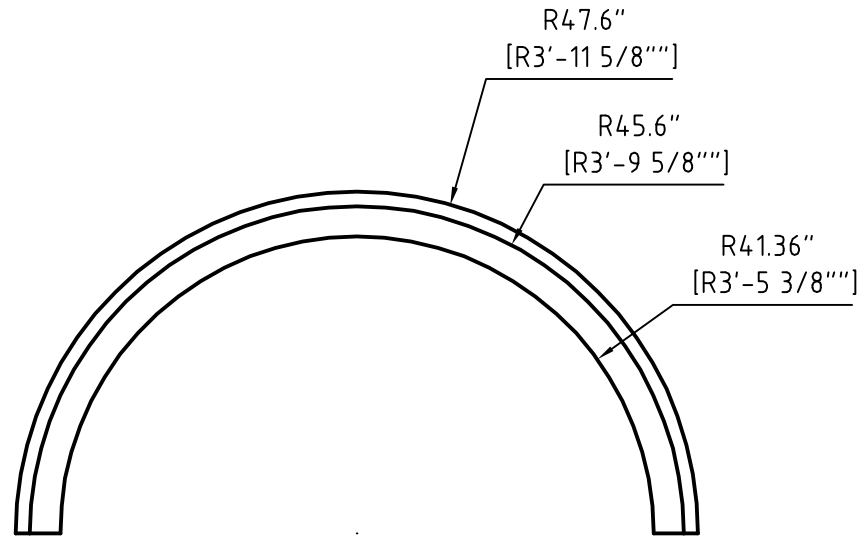
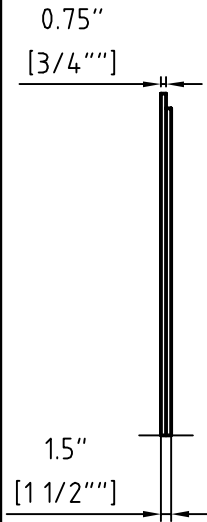

4' x 8' x 3/4"
PLYWOOD
makes 1 rail

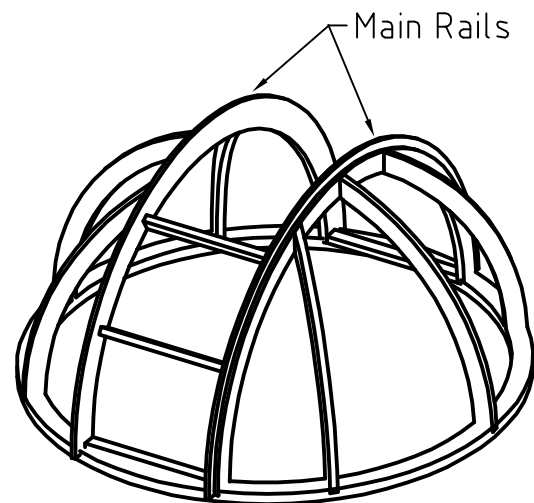
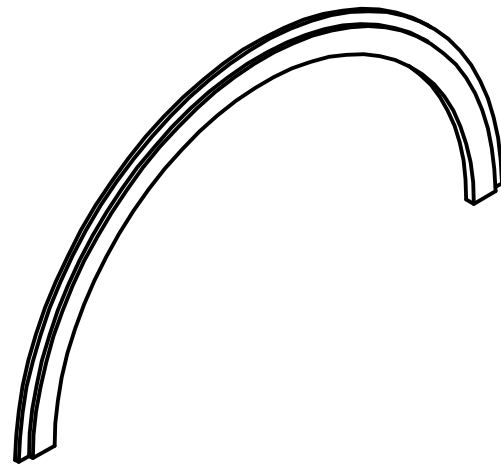

B

A

B

REV A

SHT

000000

DWG NO

A

PROPRIETARY

THE INFORMATION CONTAINED ON THIS DRAWING IS THE PROPERTY OF MIDLAND STARGAZERS AND SHALL NOT BE SHOWN OR EXHIBITED TO ANY PERSONS OR CORPORATION WITHOUT THE EXPRESS WRITTEN CONSENT OF MIDLAND STARGAZERS.

APPROVALS	DATE
DWN	
MDES	
ODES	
COAT	
PROD	
QA	
CMO	

MIDLAND STARGAZERS

MAIN RAIL

SIZE B	FSCM NO 36126	2 REQUIRED	REV A
SCALE 1/1	REF: PROJECT	SHEET 3 OF 4	

4

3

2

1